

REUSABLE AND MODULAR FORMWORK IN ABS FOR COLUMNS



geopanel star

the universal formwork for columns



- UNIVERSAL
- SIMPLE
- FAST



w w w . g e o p l a s t . i t

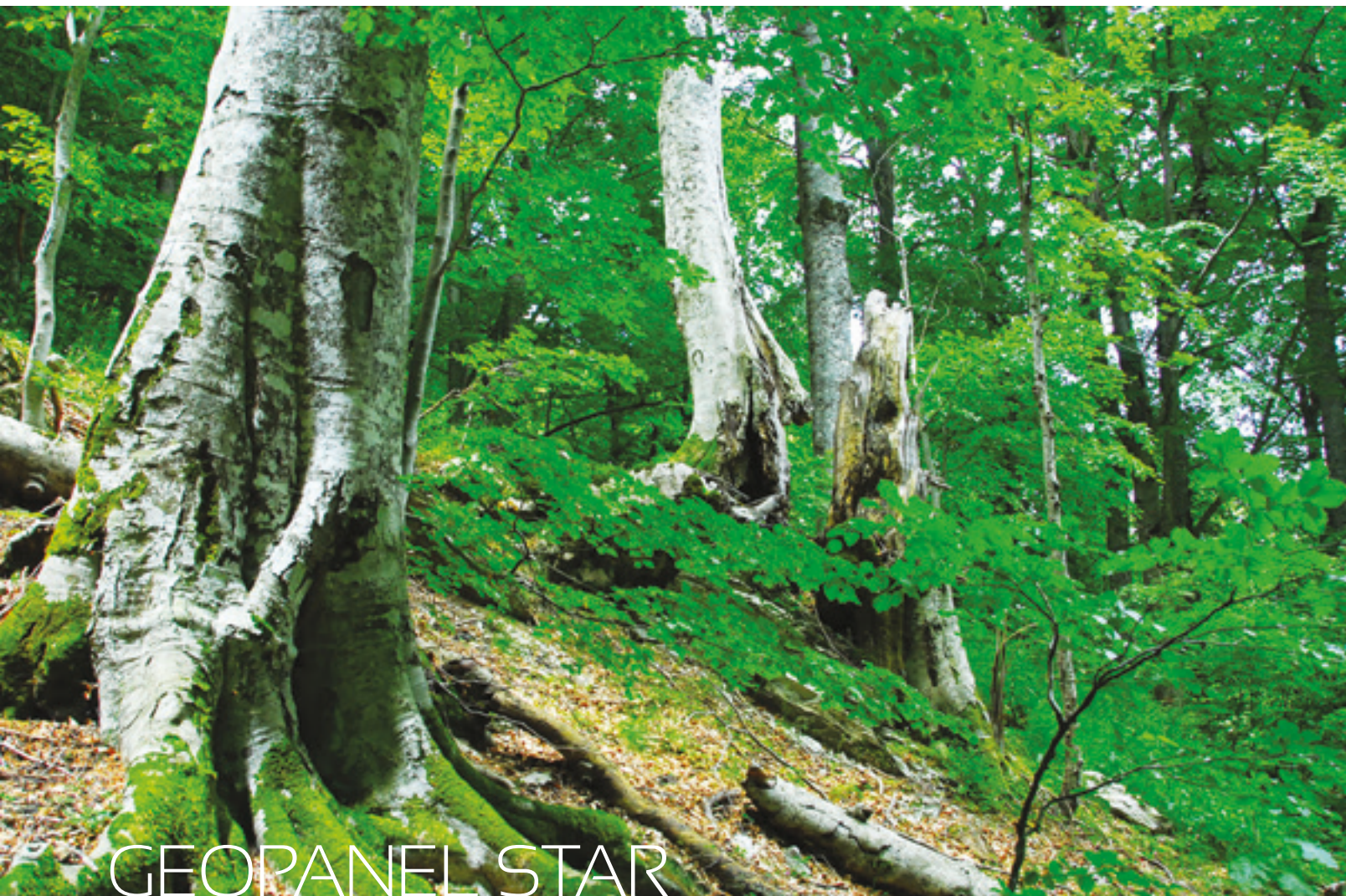

GEOPANEL STAR VISION

CONSTRUCTION and RESPECT: this is the vision that characterizes the work of Geoplast. To erect buildings respecting the environment. Starting from the choice of raw materials. Our plastic formwork perfectly embodies this principle.

THE ANNUAL WORLD CONSUMPTION OF WOOD IS EQUAL TO 1,5 BILLION M³, OF WHICH 55% IS USED IN CONSTRUCTION

After having exhausted the sources of timber in South-East Asia and Central Africa, logging is causing the deforestation of the Amazon rainforest which is considered the green lung of our planet.

During the last 3 decades almost 55 million hectares of forest were cleared in this zone, a surface equal to France surface.

In view of this problem, we decided to contribute realizing plastic forworks, using a recyclable material which is the only possible eco-friendly alternative to wood and cardboard.

We realized them taking into consideration their weight in order to reduce the energy consumption. Energy is necessary for their movement and we think that this is a form of respect too.

Geoplast S.p.A. in Green Building Council Italia,
The Network of Green Building.





THE ALTERNATIVE TECHNOPOLYMER FORMWORK

GEOPANEL STAR is an adjustable formwork for square and rectangular concrete columns. Made of ABS technopolymer, it is a new idea of formwork: light and modular, it's easy to handle and maintain, convenient to transport and to store for further use.



Why ABS

(Acrylonitrile Butadiene Styrene)

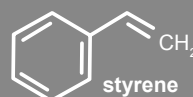
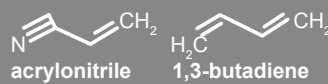

High mechanical strength

Shock resistance

Thermal stability
(-30°C / +70°C; -22°F / +158°F)

Very high surface quality

Recyclable material

GEPANEL STAR ADVANTAGES



The only light, reusable and modular system for the construction of reinforced concrete columns

light



Weighting just 10 kg, **GEPANEL STAR** can be handled quickly on-site without the use of cranes or mechanical lifting devices

fast



Light and easy to assemble, it can be installed and handled by a single person

modular



All the elements are 600 mm long. The elements needed for the pour are assembled and used as required

reusable



GEPANEL STAR is cost effective as it can be used more than **100 times** with an appropriate cleaning and use

dismantling



Concrete doesn't stick to plastic: dismantling is extremely easy, the form can be cleaned using just a little water, without any need of detergents

storage



GEPANEL STAR can be safely and conveniently stored even in a damp and wet environment

GEOPANEL STAR MODULAR FORMWORK

Up to 80 kN/m² fresh concrete pressure

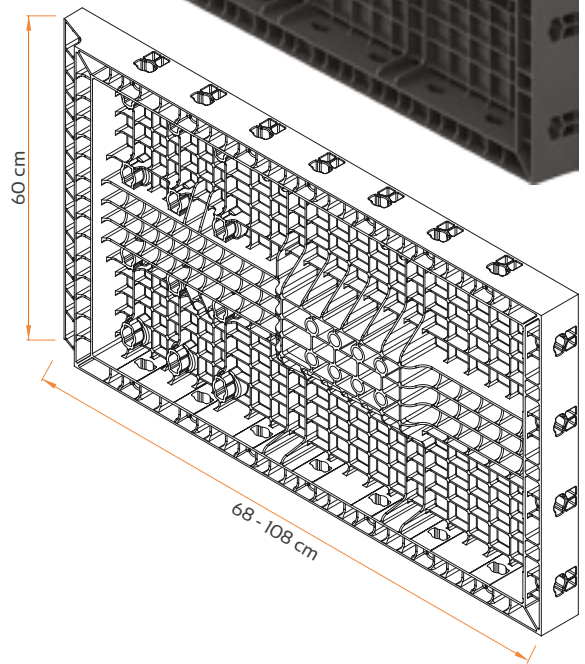
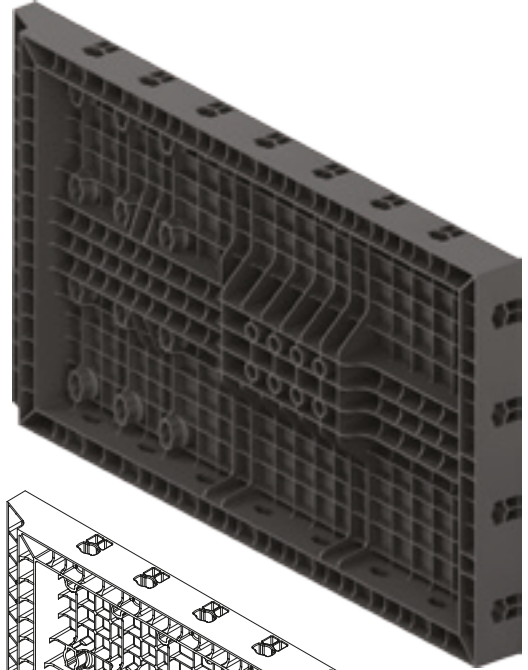
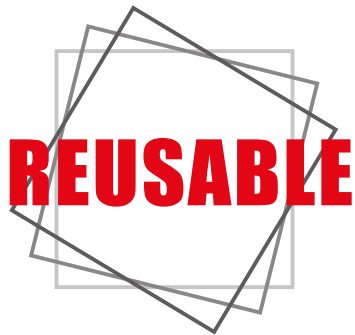

GEOPANEL STAR MATERIAL

Acrylonitrile Butadiene Styrene	ABS
Coefficient of thermal expansion	0.05 mm/m/°C

SIZE

Smallest side	120 mm
Largest side	1000 mm
Height	600 mm (605 mm)

The handle

The standard fixing element for all Geoplast Formworks

- Light and intuitive
- Firmly locks with a simple 90 degree turn
- Strength guaranteed by special engineered materials

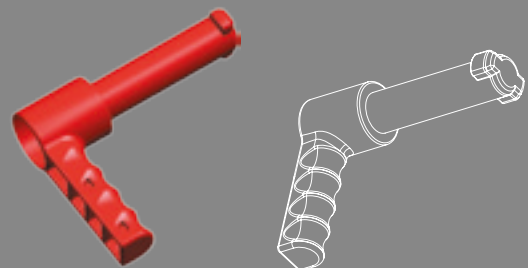

HANDLE MATERIAL: POLYAMIDE - COEFFICIENT OF THERMAL EXPANSION 7-10 (1/K 10⁻⁵)

Items and accessories

DIMENSIONAL TABLES



**GEOPANEL STAR
20-60**



**GEOPANEL STAR
25-65**

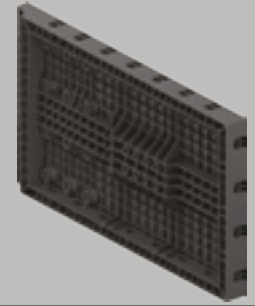

**GEOPANEL STAR
70-100**

actual size (mm)
material
weight (kg)
package size (mm)
No. pieces per pallet
No. handles

680 x 605 x 80

ABS

6.40

750 x 1200 x H2580

64

8

731 x 605 x 80

ABS

6.80

750 x 1200 x H2580

58

8

1080 x 605 x 80

ABS

9.60

750 x 1200 x H2580

40

11

GEOPANEL STAR
20/60

GEOPANEL STAR
25/65

GEOPANEL STAR
70/100

DIMENSIONS
COLUMNS SIDES

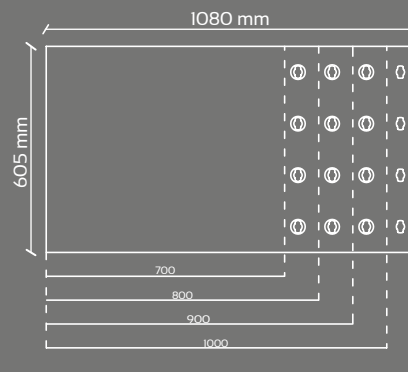
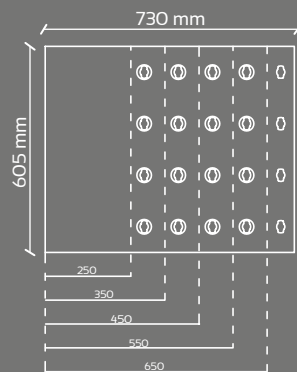
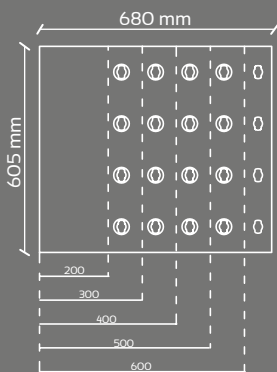

HOLES
TIE RODS

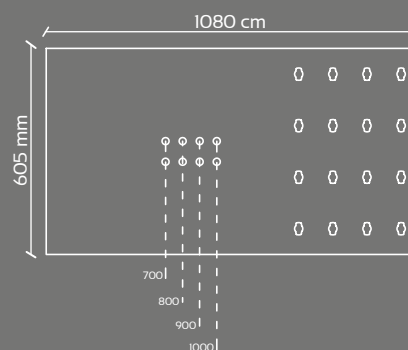
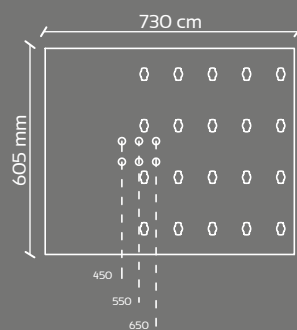
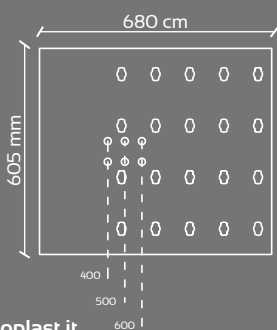

**GEOPANEL
35x60**

35.3 x 60.5 x 8

ABS

3.36

750 x 1210 x H2350

118

6

COMBINATIONS AND ELEVATIONS

COMBINATION SIZES	STAR 12-15/20-60	STAR 25 - 65	STAR 70 - 100
-------------------	------------------	--------------	---------------

STAR 12-15/20-60

A - B - D

A - B - D

C - E

STAR 25 - 65

A - B - D

C - E

STAR 70 - 100

F

The **GEOPANEL STAR** panel range is adjustable to a range of column sizes from 120 to 1000 mm. The different panels can be combined with each other in order to obtain the desired size combination.

1

2

3

ELEVATION FOR SIDES EQUAL TO: 120, 150, 200, 250, 300, 350, 400 mm

ELEVATION FOR SIDES EQUAL TO: 450, 500, 550, 600, 650 mm

ELEVATION FOR SIDES EQUAL TO: 700, 800, 900, 1000 mm

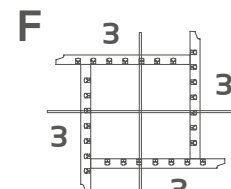
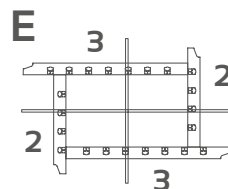
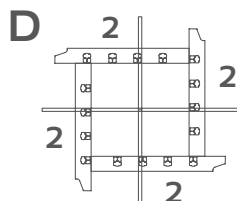
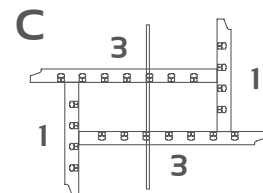
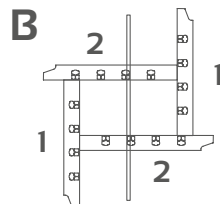
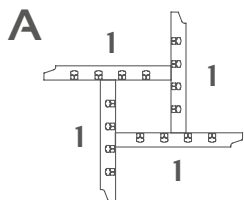
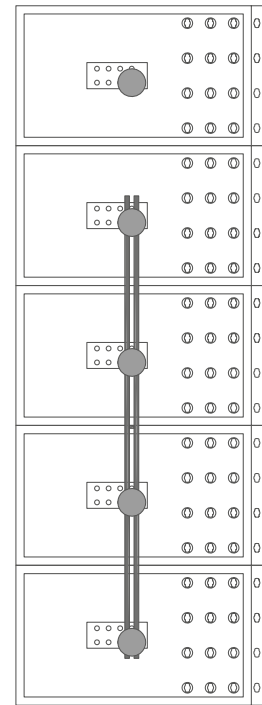
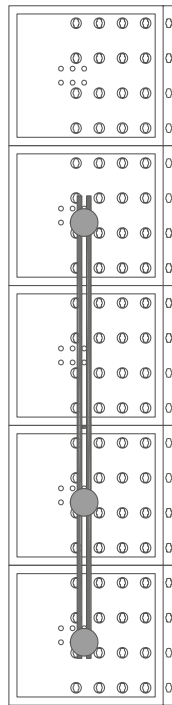
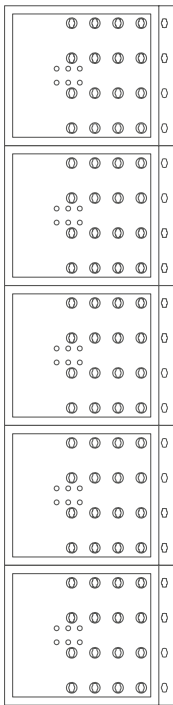

GEO PANEL STAR INSTALLATION GUIDE

- Ⓐ HANDLE
- Ⓑ SPACER
- Ⓒ GEOPANEL STAR
- Ⓓ TIE ROD
- Ⓔ ALIGNMENT BAR
- Ⓕ ANCHOR NUT

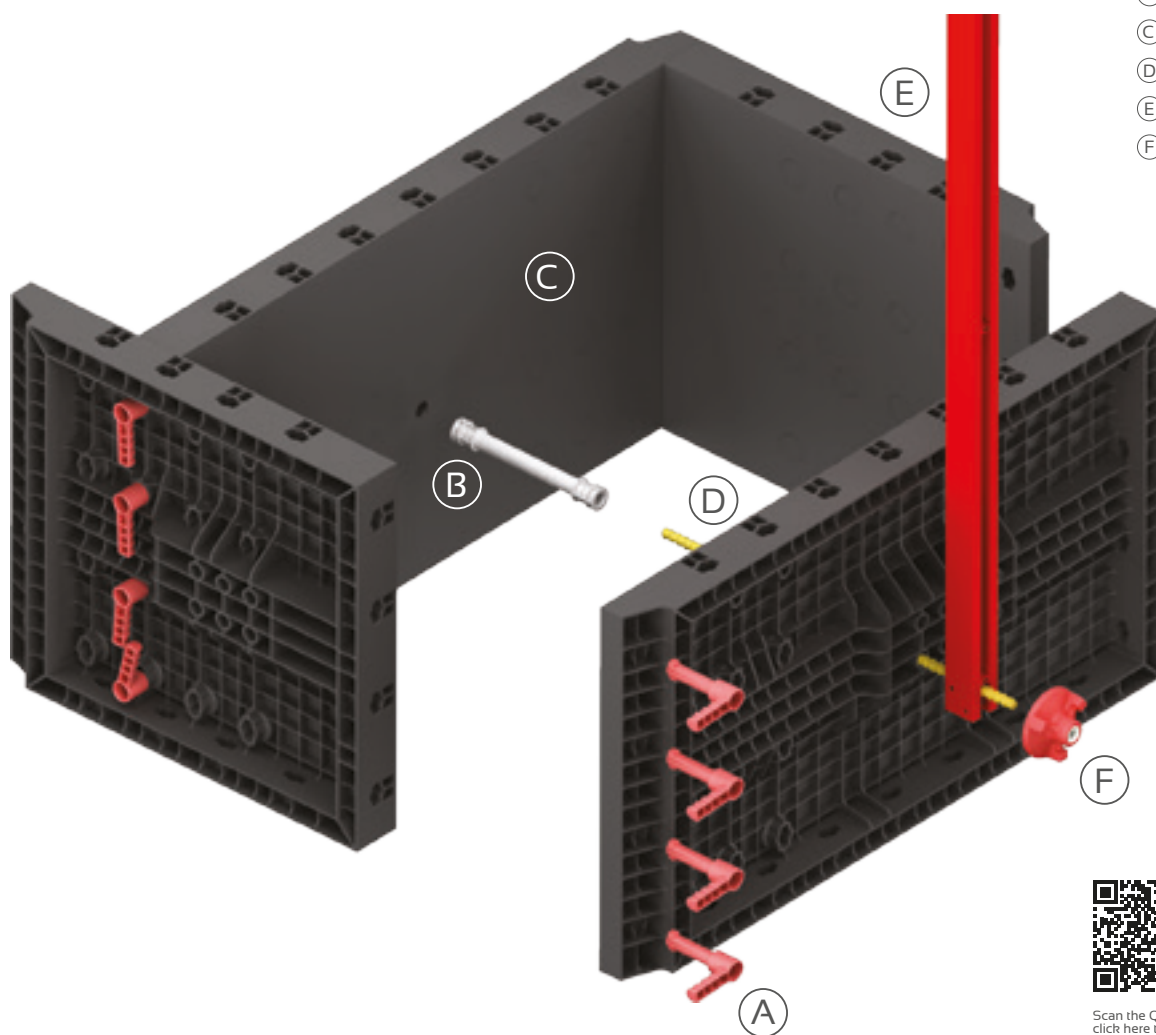





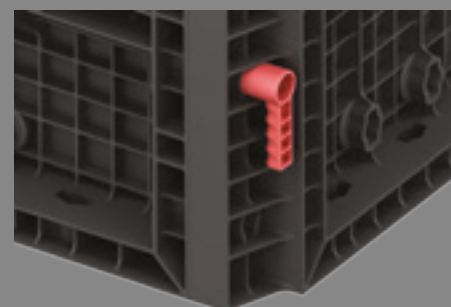
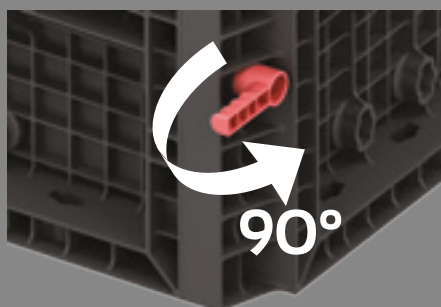
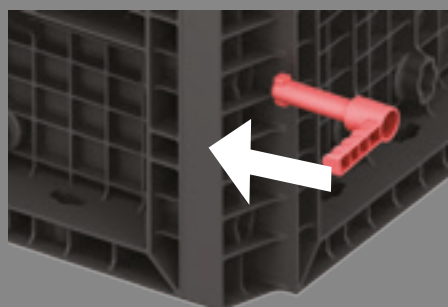





Scan the QR-code with your smartphone or click here to access the video!

Handle locking



ACCESSORIES

			
	HANDLE	CAP 43	CAP 25
WEIGHT (kg)	0.1	0.014	0.006
MATERIAL	NYLON	ABS	HDPE
			
	ANCHOR NUT for tie rod	BRACE CONNECTOR	CONNECTOR PLATE
WEIGHT (kg)	0.370	1.20	0.85
MATERIAL	NYLON	STEEL	STEEL
			
	SPACER 150/200/250/300/350/400	TIE ROD 300/750/1000/1500	
WEIGHT (kg)	0.035 -> 0.070	1.075 -> 2.150	
MATERIAL	HDPE	STEEL	
			
	ALIGNMENT BAR 5000/7500/10000/15000/20000	CHAMFER 220x100 / 320x150	
WEIGHT (kg)	2.60 -> 9.50	0.05 -> 0.08	
MATERIAL	STEEL	PVC	

COLUMN APPLICATION



The versatile formwork

GEOPANEL STAR is a high-strength column formwork made of tough ABS polymer. It can take all the wear and tear of a construction site while simplifying the concrete forming tasks, re-

ducing the crane workload and improving the site logistics. Adjustable to a range of column sizes, **GEOPANEL STAR** as a very useful tool for construction sites of any size.

Easy to use
Crane workload reduction
Reusable more than 100 times





COMBINATION WITH GEOPANEL

FOCUS
GEOPANEL
35X60

Combine all Geoplast Formwork

GEOPANEL STAR panels are perfectly compatible with the **GEOPANEL** wall formwork. All panels of the two ranges interlock creating very interesting pos-

sibilities: extend over and beyond the size limits of the **GEOPANEL STAR** panels, seamlessly to form columns inserted in RC walls and produced in a single pour.

The **GEOPANEL 35 x 60** panel doubles as as **GEOPANEL STAR 12-15**: it is used to form column size of 120 and 150 mm and

combines with all panels of the **GEOPANEL STAR** as well as the **GEOPANEL** ranges.

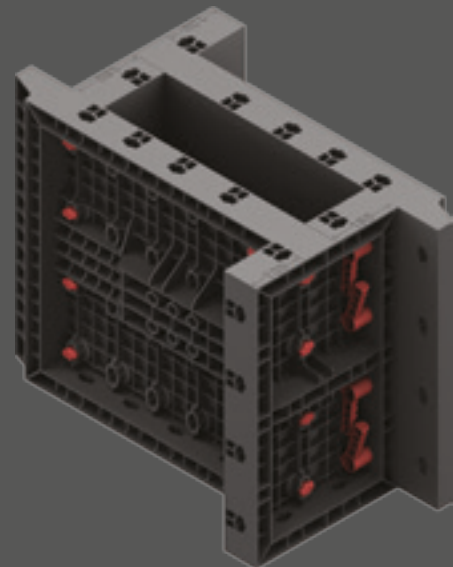
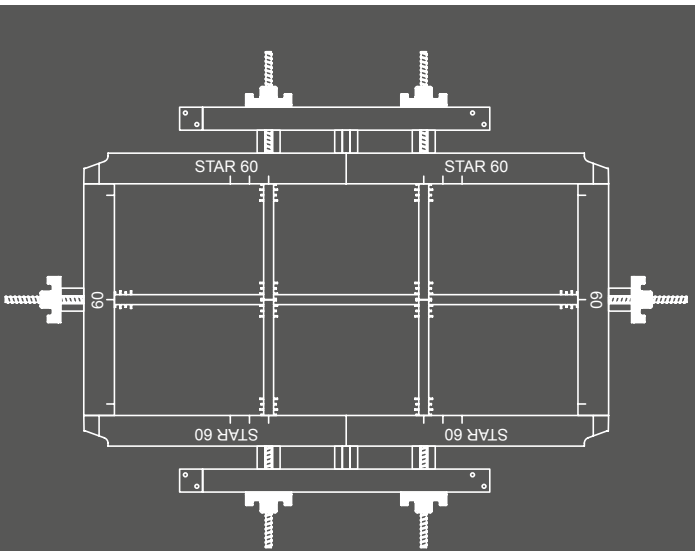

LARGE BUILDINGS



Ideal for serial columns

GEOPANEL STAR reinforced concrete frames typically include a large number of columns repeating both vertically and horizontally. The **GEOPANEL STAR** formwork is the ideal tool for RC frames: fast to erect and

dismantle, can be handled both with and without a crane, is adjustable to large size range, does not need highly trained personnel for operation. A time saver and a cost-cutter.

Simplifies operations
Long life-time
Costs reduction





FOUNDATION SPECIALIST

Geopanel Star back to basics

The **GEOPANEL STAR** and plinth-formwork, making the task really easy: no alteration, cutting or trimming is necessary and site waste is greatly reduced. Its versatility and ease of use make it ideal as footing

High production rate
No lifting equipment needed
Large size range

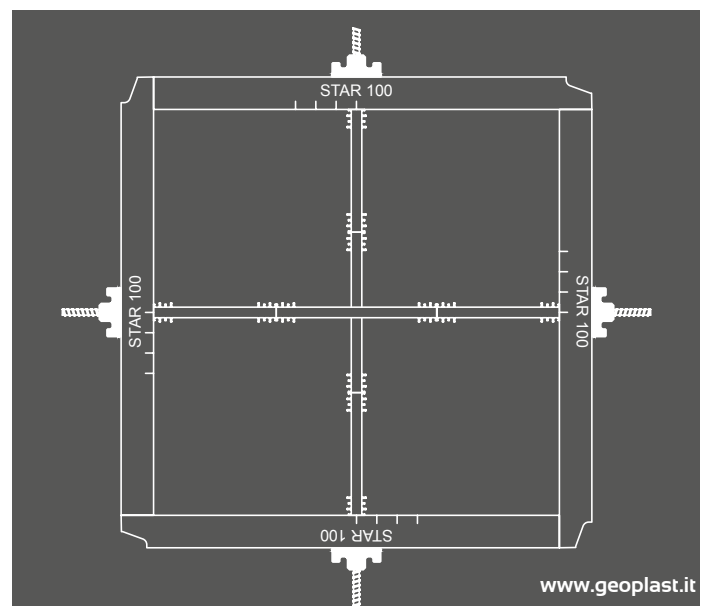

GEOPANEL STAR TECHNICAL GUIDELINES

A) SHORING

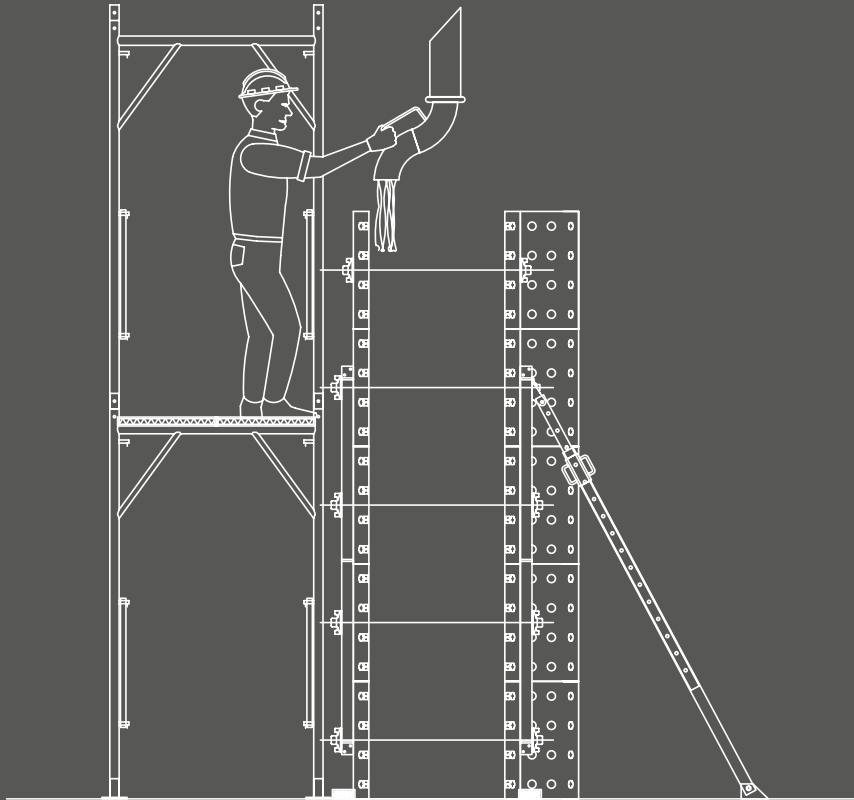

Shoring is performed using a connector plate to connect push-pull props to the formwork. Connector plates are available in various sizes to suit any commercially available prop.

B) GROUND ANCHORING

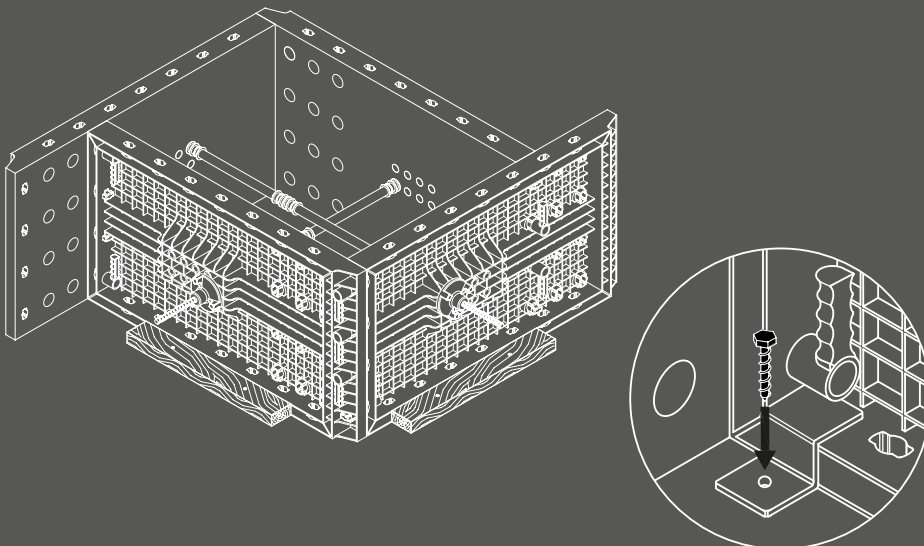

Anchoring to the ground to avoid lifting of the formwork is done using metal brackets and timber.

OPERATION AND MAINTENANCE REQUIREMENTS

POUR

Only immersion concrete vibrators systems are allowed. ABS formwork are not fireproof so do not place it close to hot objects or open flames.

HANDLING

Use lifting hook to lift the already assembled panels with a crane. Before lifting make sure that the lifting cables have an uniform draft.

PANEL CLEANSING

After every use, cleanse the panel with water (preferably with a pressure washer) any deposit of concrete should be removed with a spatula or a wire brush.

RELEASING AGENT

As long as the panels surface does not show signs of wear, no releasing agents are required.

STORAGE

In order to facilitate the handling and the lifting of the panels and all the accessories, store them on pallets or battens to keep them off the ground. Although the product does not suffer weathering, its preferable to store the panels in a dry place away from direct sunlight.

RATE OF RISE DIAGRAM

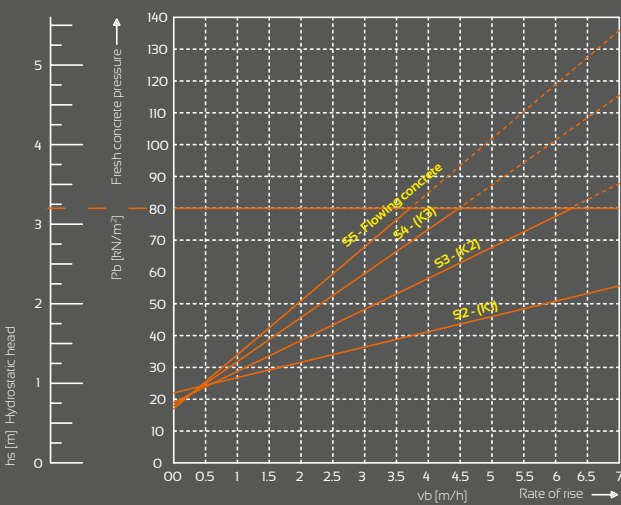

CONSISTENCY CLASS	UNI EN 206:2006		DIN 18218	
	CLASSIFICATION	SLUMP	CLASSIFICATION	SPREADING
Wet	S1	10 - 40 mm		
Plastic	S2	50 - 90 mm	F1 (K1)	≤ 34 cm
Stiff	S3	100 - 150 mm	F2 (K2)	35 - 41 cm
Soft	S4	160 - 210 mm	F3 (K3)	42 - 48 cm
Flowing	S5	≥ 220 mm	F4 (Flowing)	49 - 55 cm

ABRAMS CONE

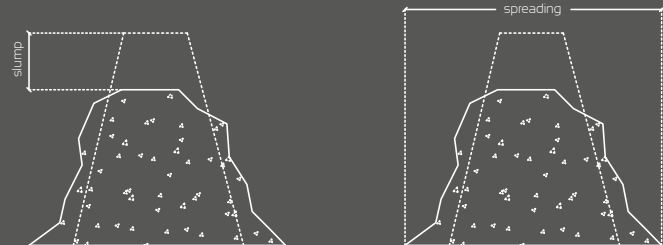

SAFETY REQUIREMENTS

The operations of placing, assembling, dismantling, plumbing, handling and cleaning of the product **GEOPANEL STAR**, as well as the pouring of the concrete, must be carried out by competent and properly trained personal or under supervision of the site manager or a technician of **GEOPLAST S.p.A.**, who must ensure that:

- All above mentioned operations are carried out properly,
- Every person working with the formwork is equipped with suitable tools and personal protective equipment to perform all necessary actions in full compliance of the safety standards,
- All panels and supplied accessories have to be checked before use, those which do not meet the minimum standard of reliability and safety due to any breakage and/or deformation must be discarded,
- The formwork are installed on a perfect flat surface, so as to work safe and ensure a perfect shoring and plumbing of the pillars,
- All connection, alignment and plumb accessories of the formwork need to be properly tightened and secured to the ground before starting the pour.

GEOPLAST S.p.A. disclaims any liability or responsibility arising from improper use of **GEOPANEL STAR** formwork. Any assembly of molds and/or use of accessories not otherwise described in these guidelines must first be approved by **GEOPLAST S.p.A.**



GEOPLAST S.p.A.

35010 Grantorto PD - Italia - Via Martiri della Libertà, 6/8

tel +39 049 9490289 - fax +39 049 9494028

e-mail: geoplast@geoplast.it - www.geoplast.it

